

GRUPO  
**SGC**

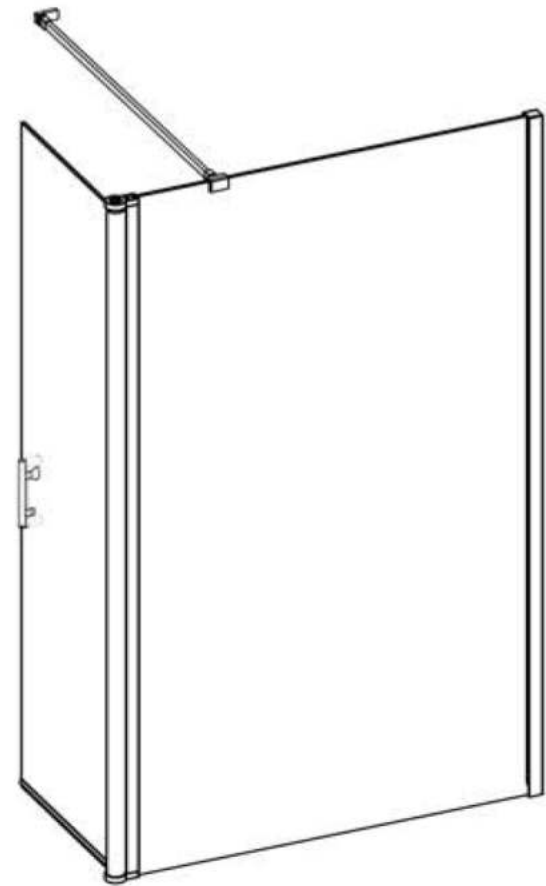

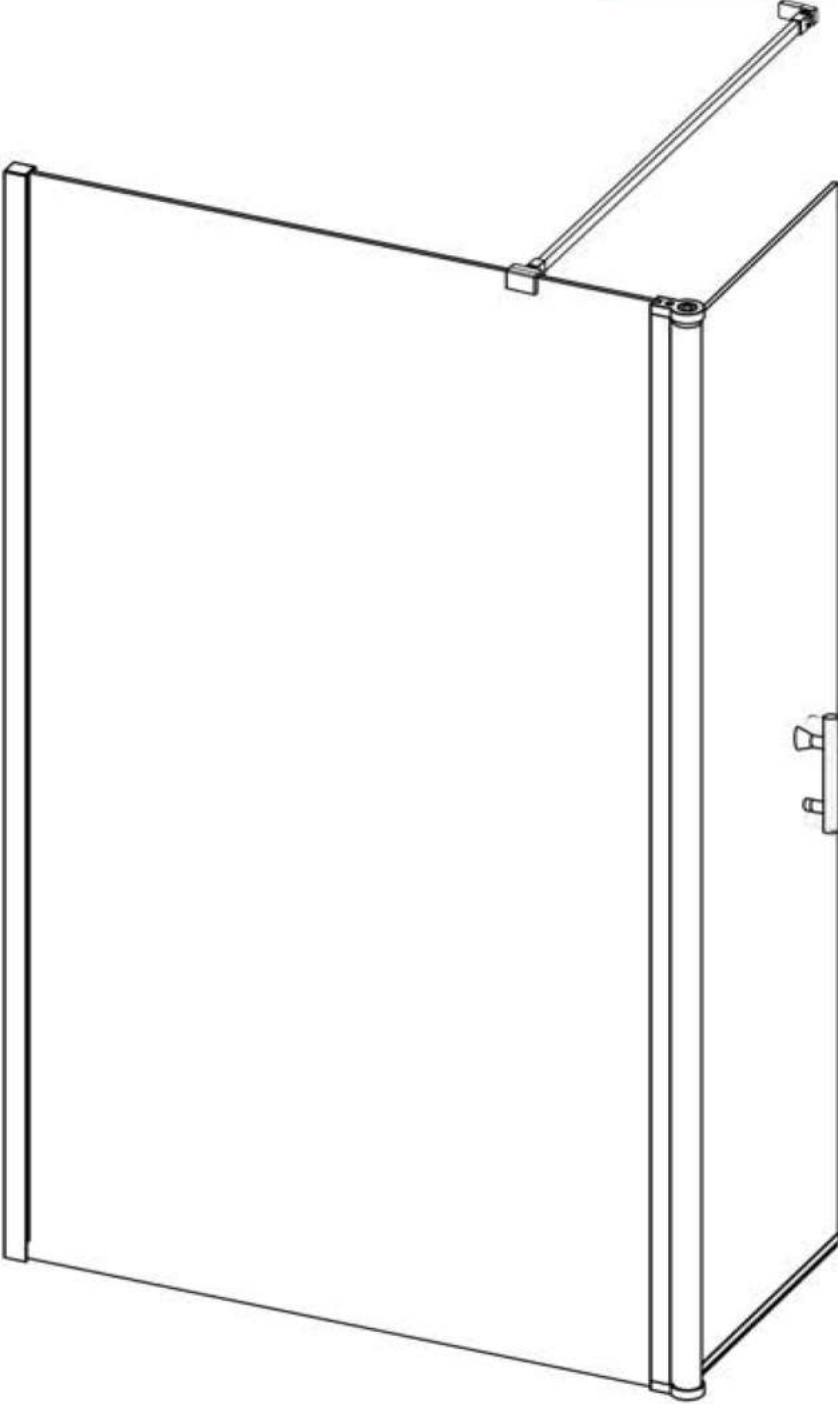

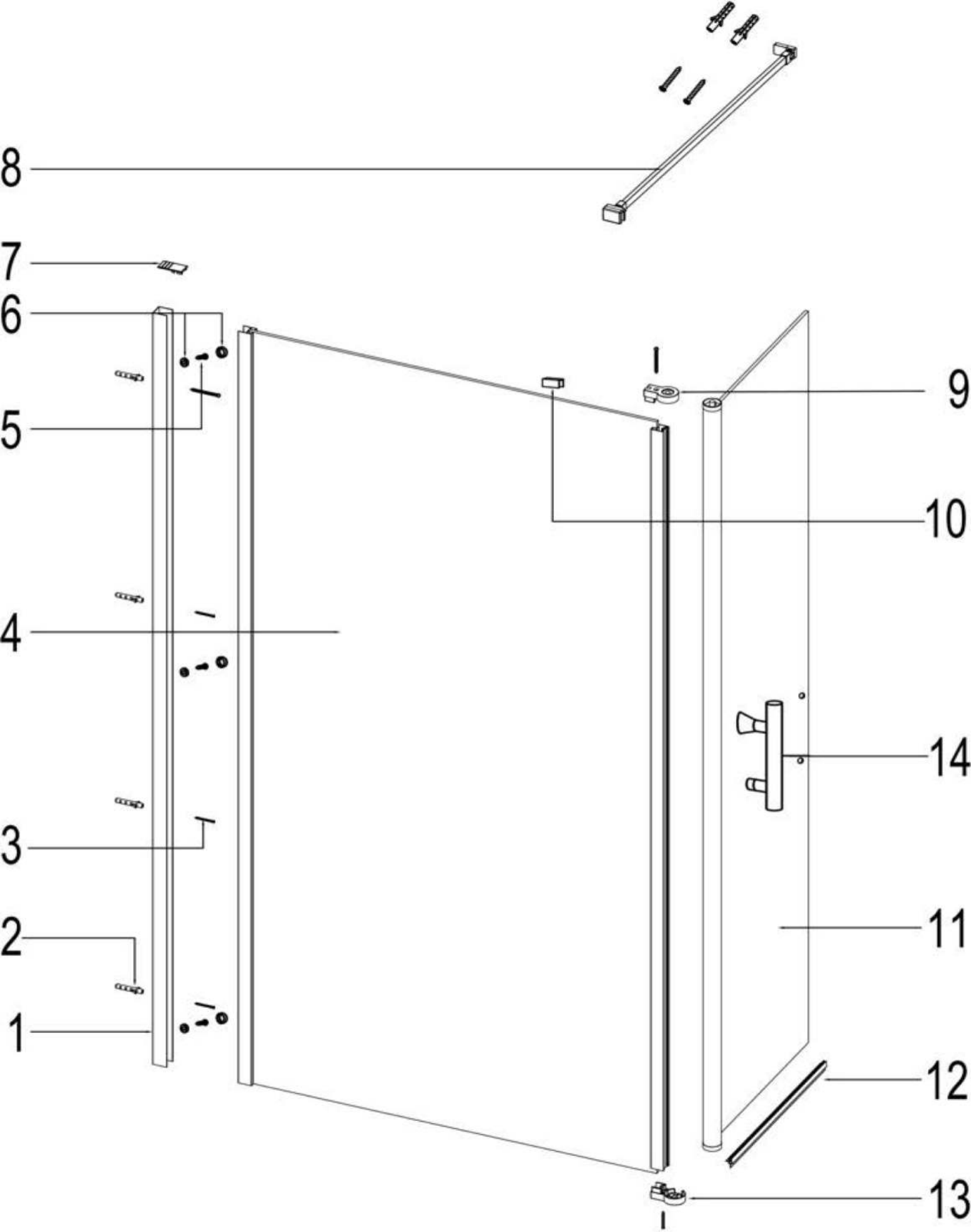

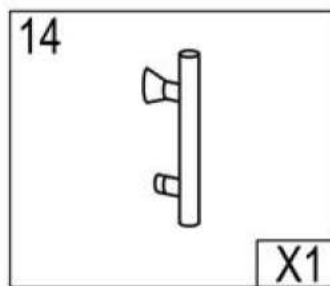
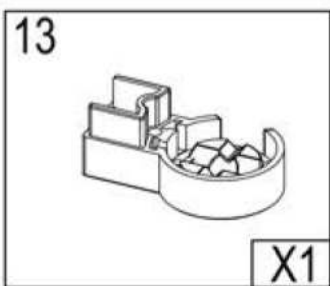
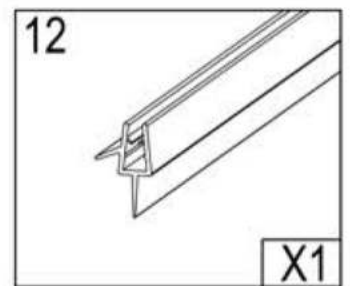
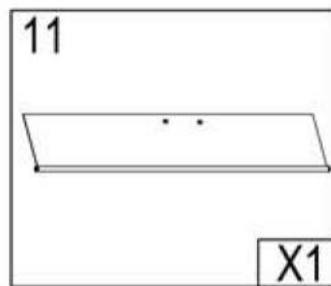
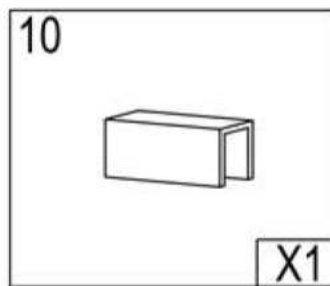
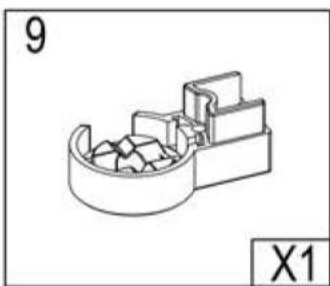
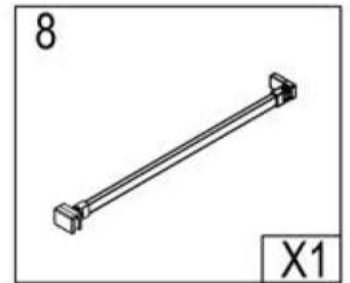
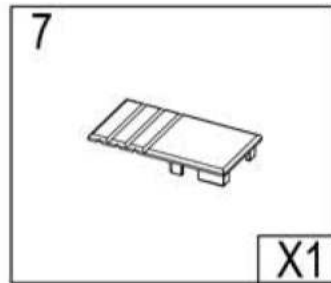
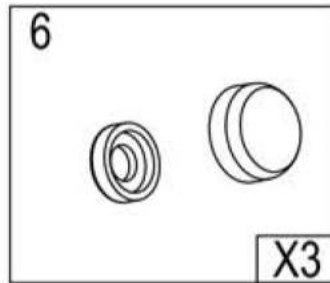
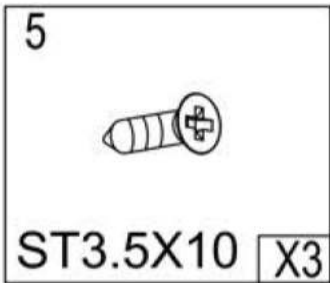
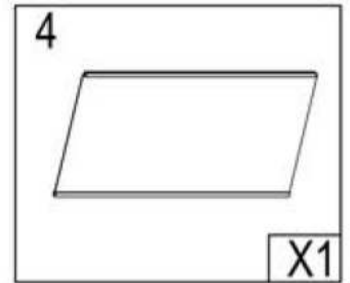
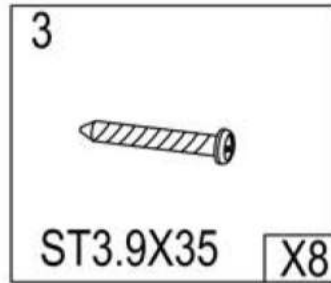
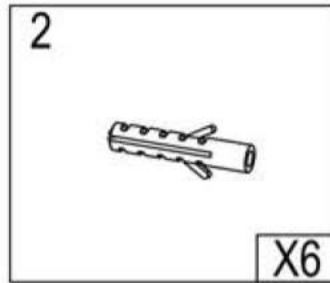
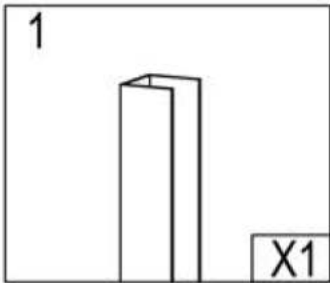
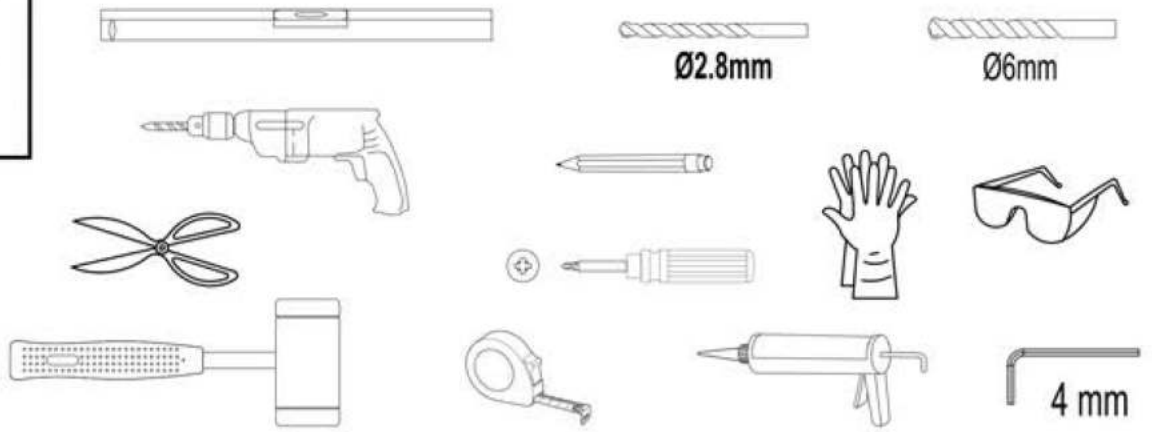
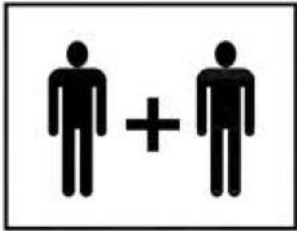
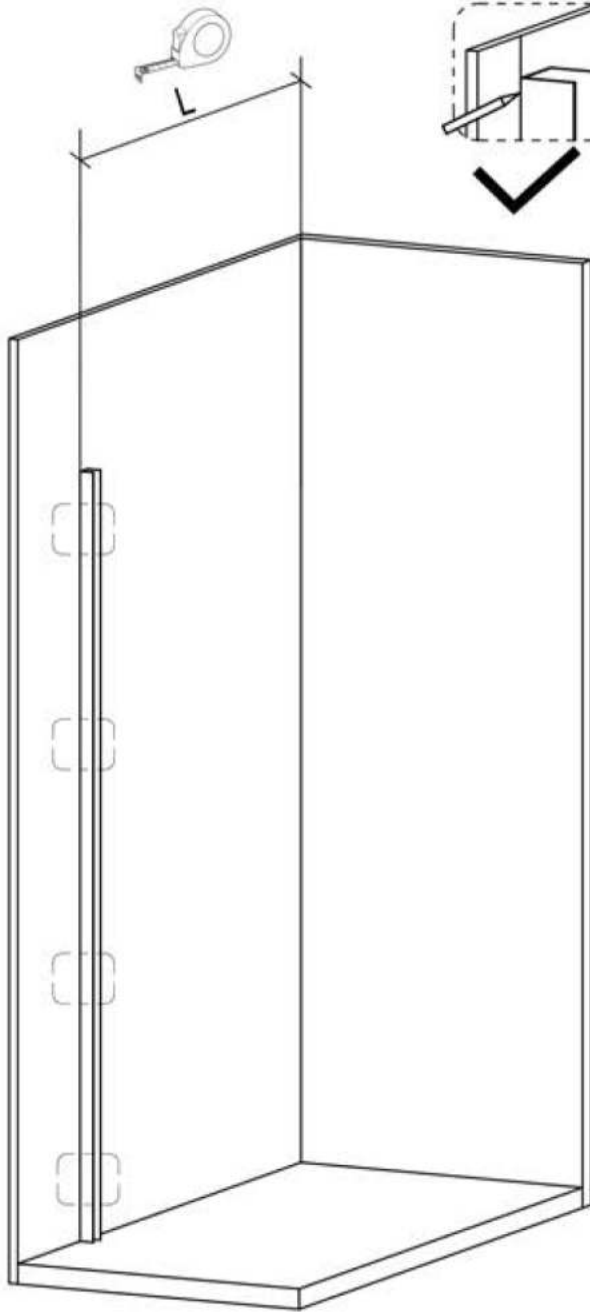
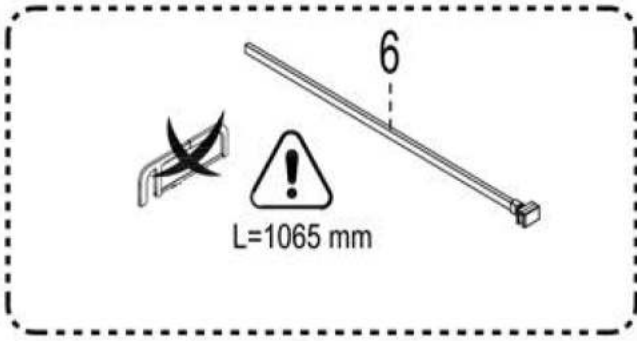

LH

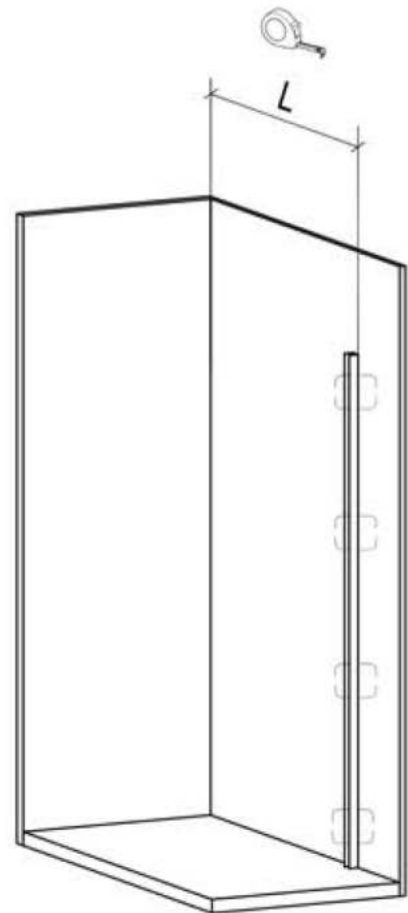
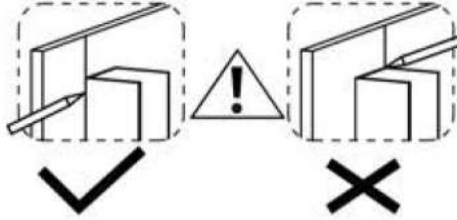

RH

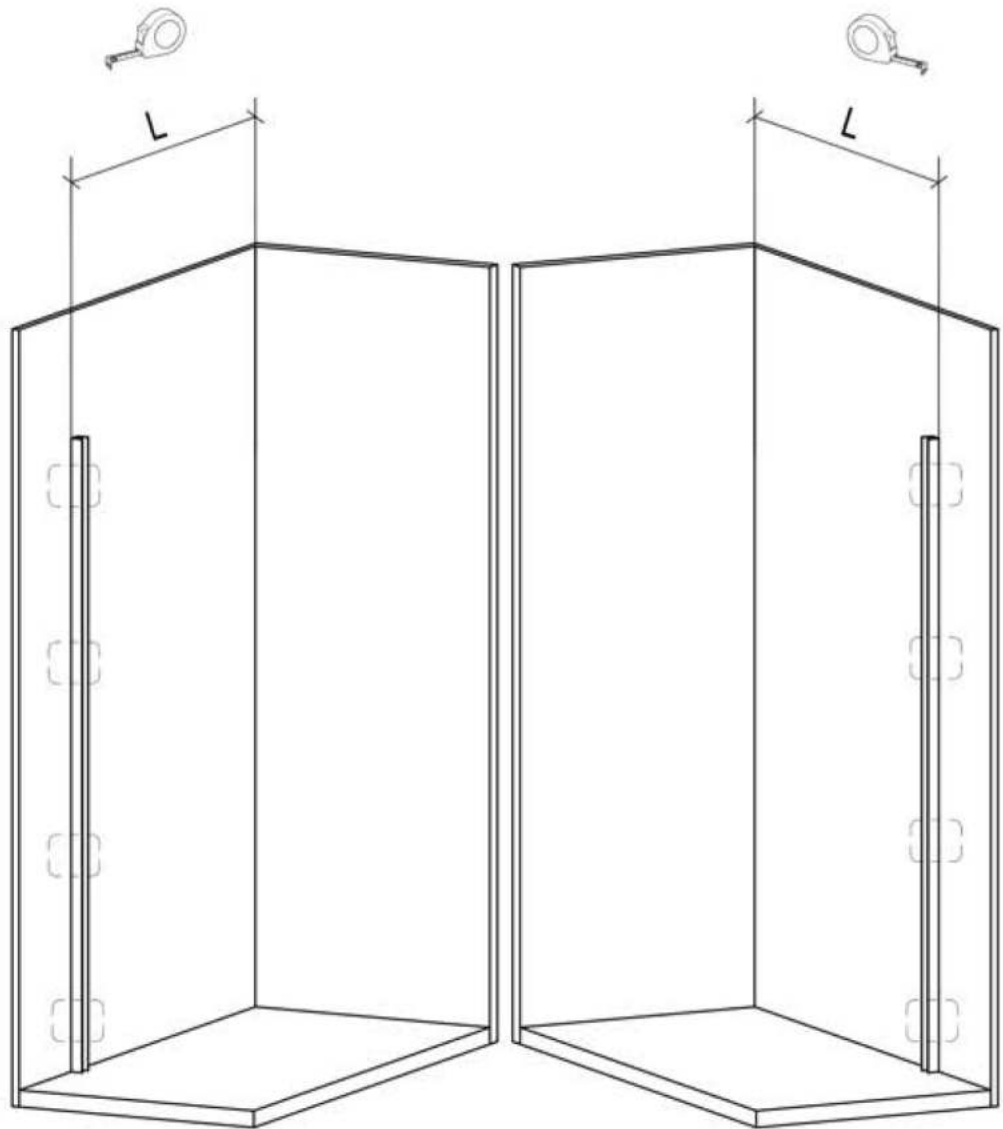
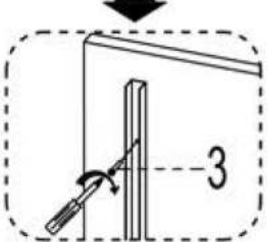
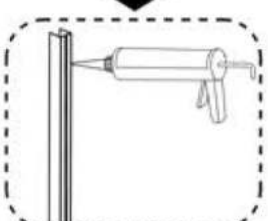
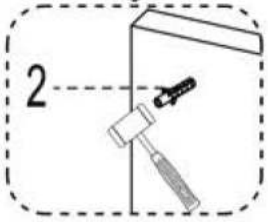
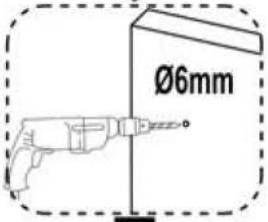
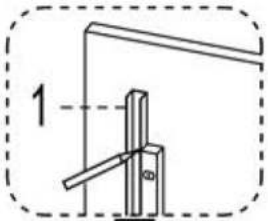
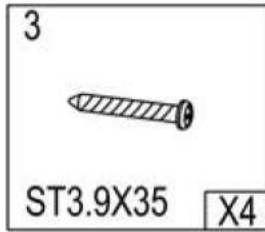
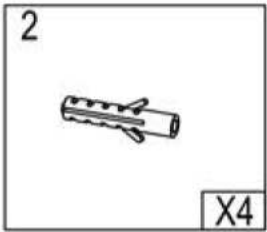
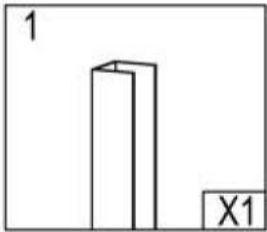
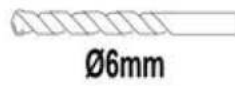
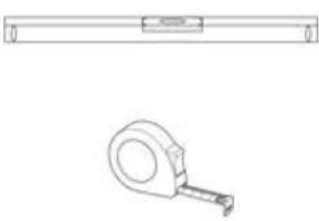

LH

RH

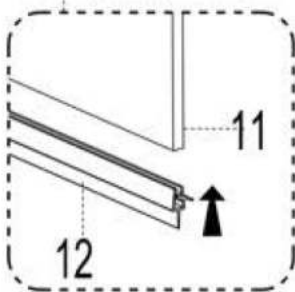
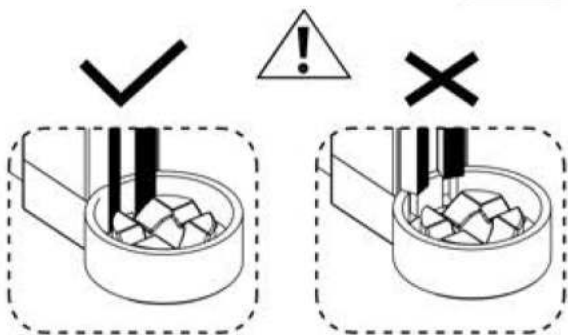
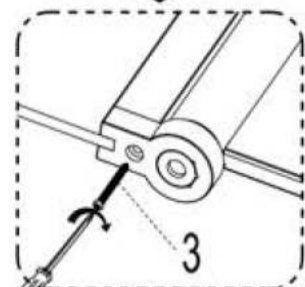
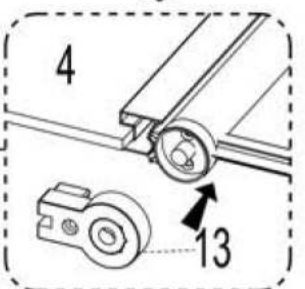
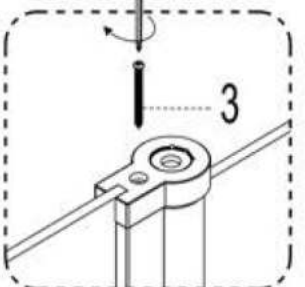
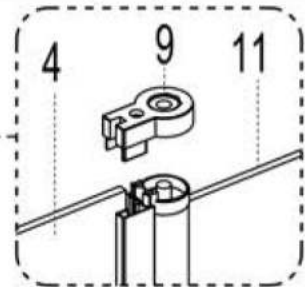
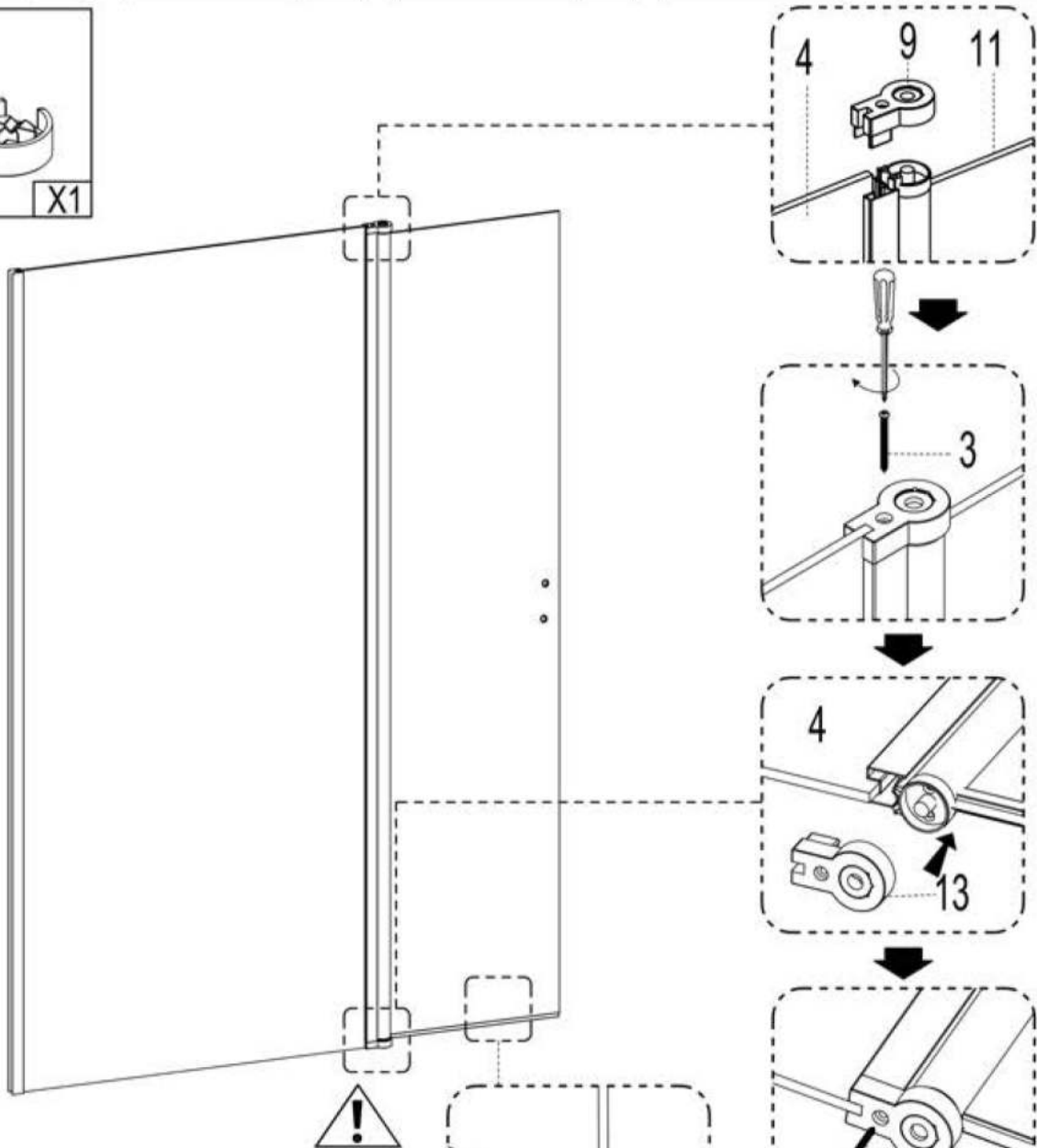
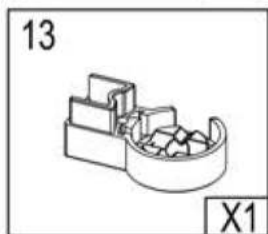
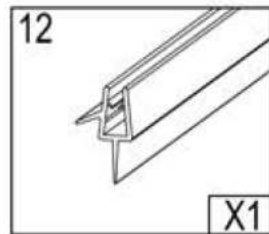
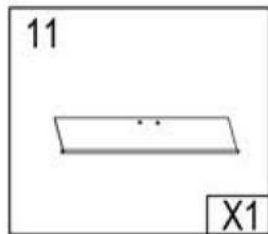
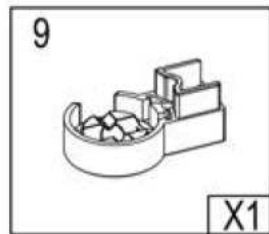
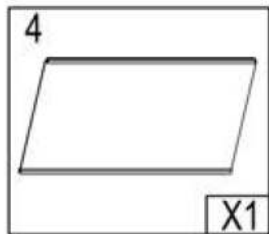
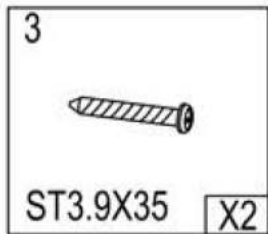



Ø2.8mm

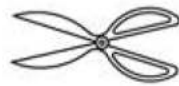
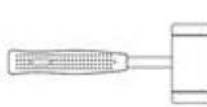

5



ST3.5X10 X3

6

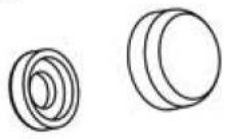

X3

7



X1

