

GRUPO
SGC

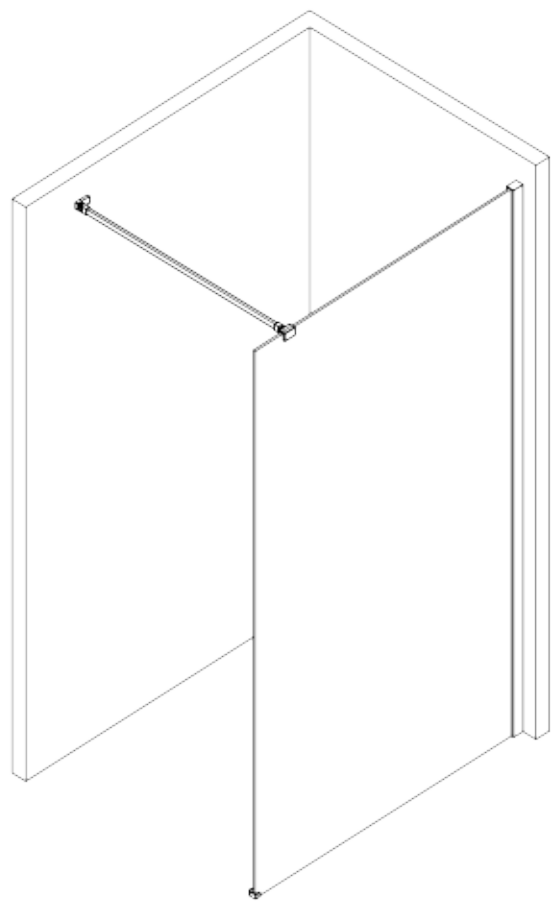

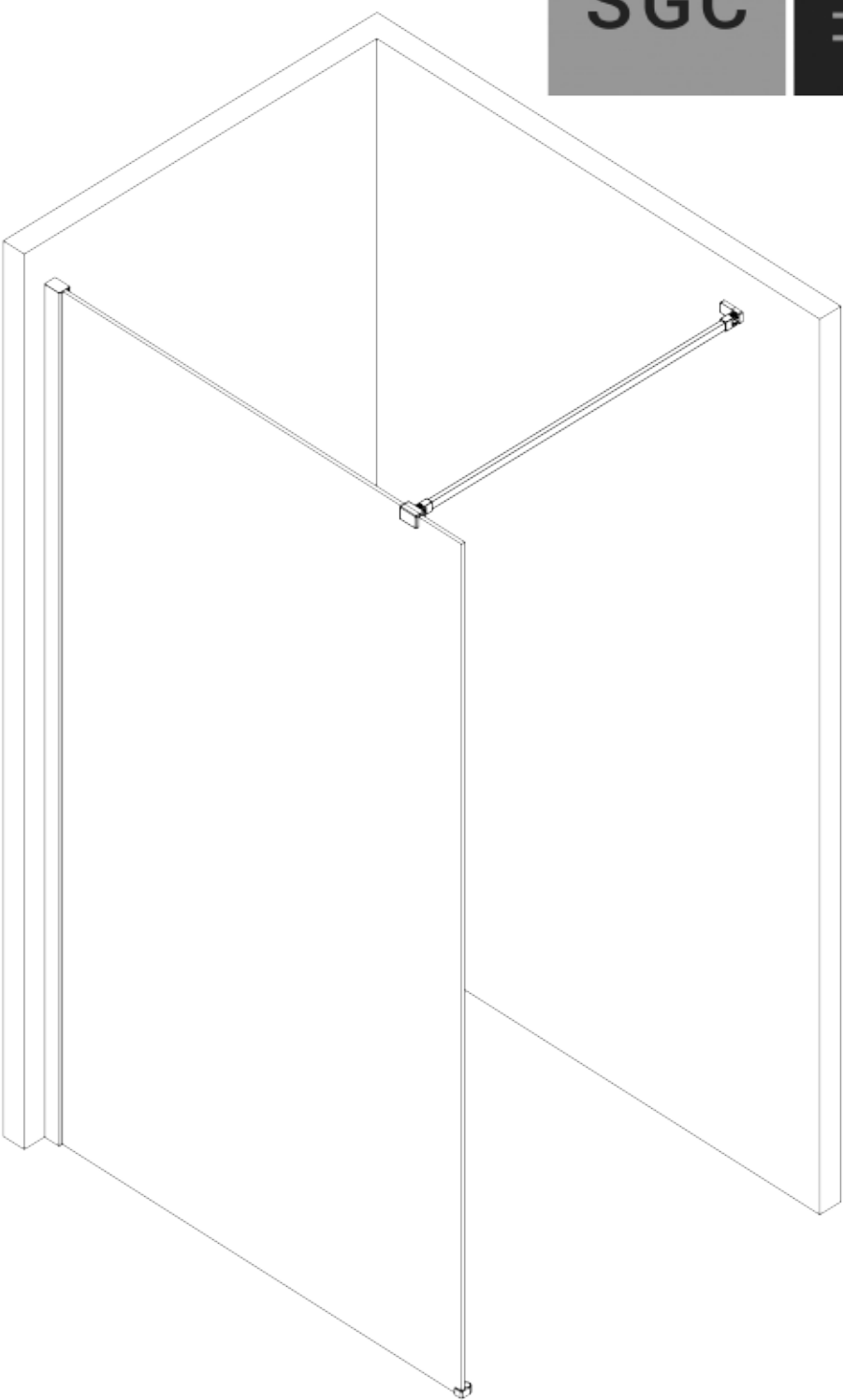

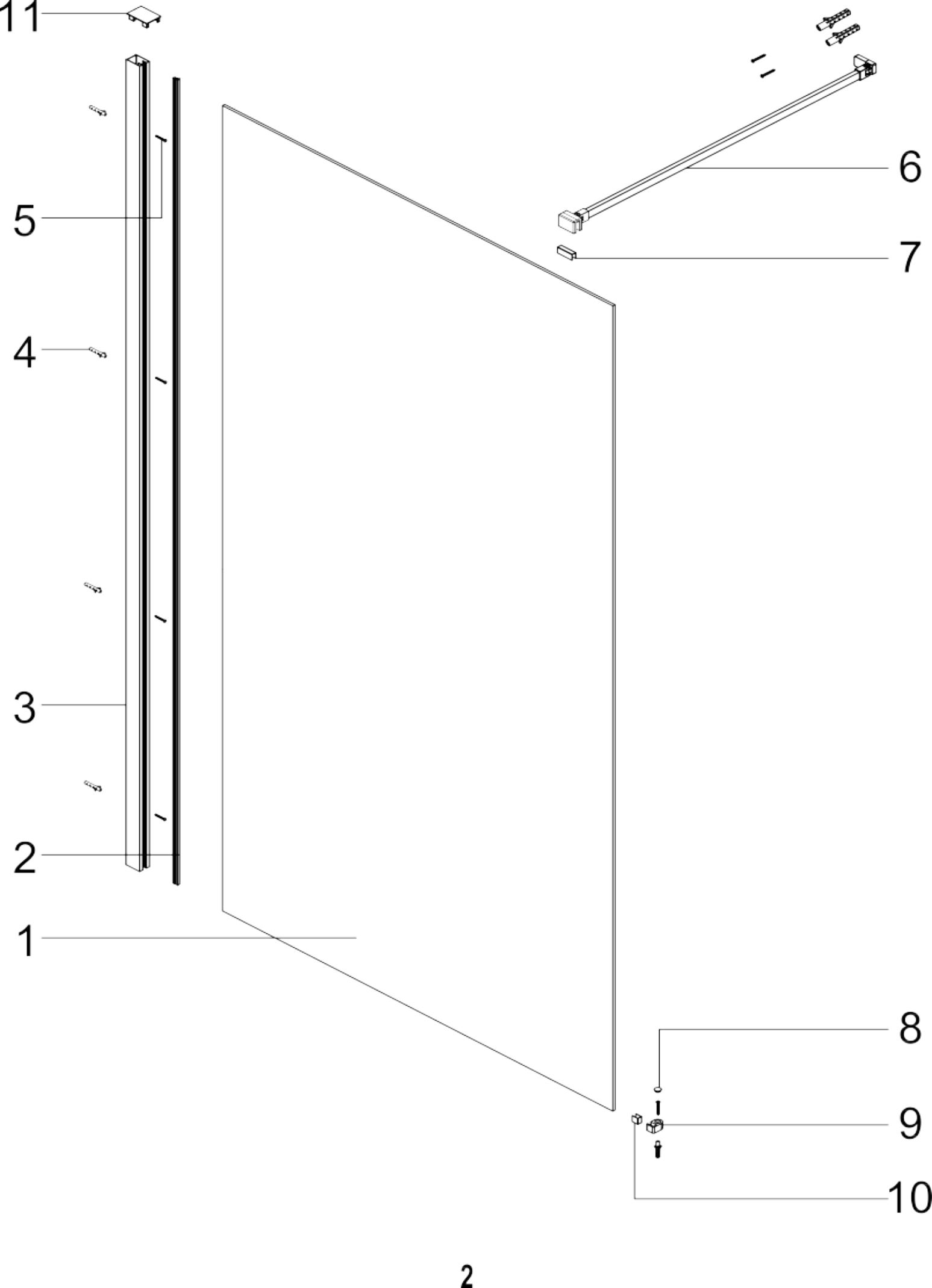

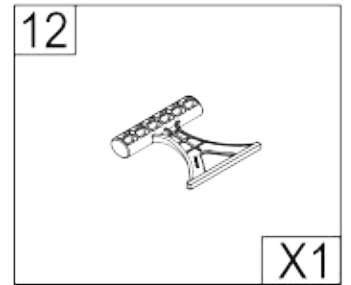
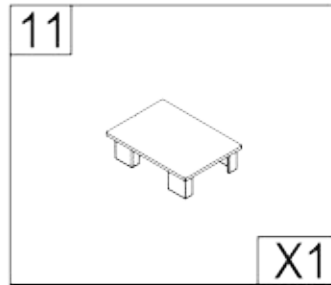
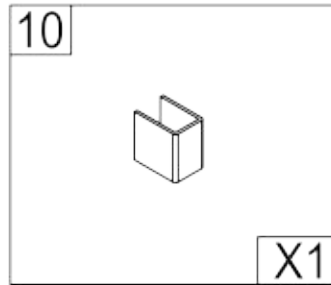
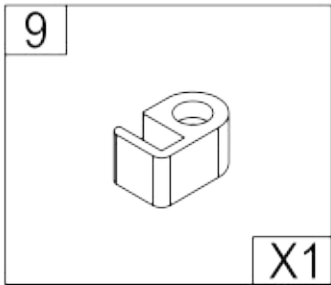
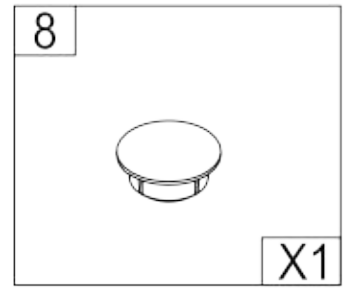
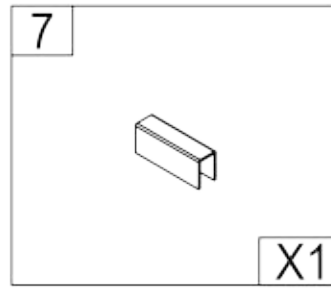
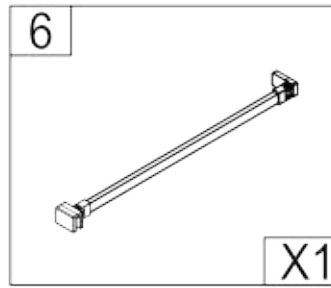
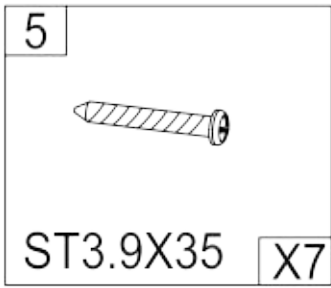
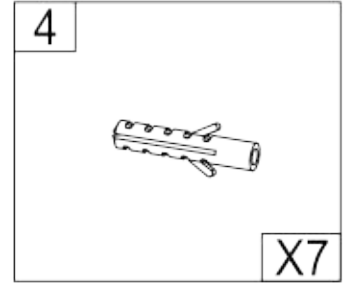
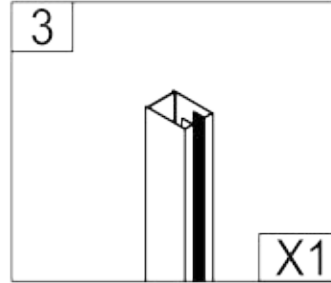
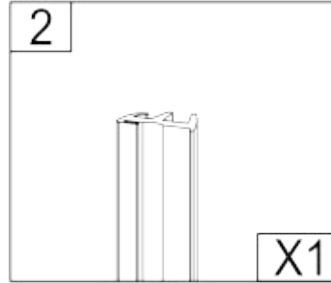
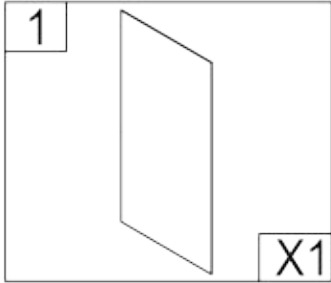
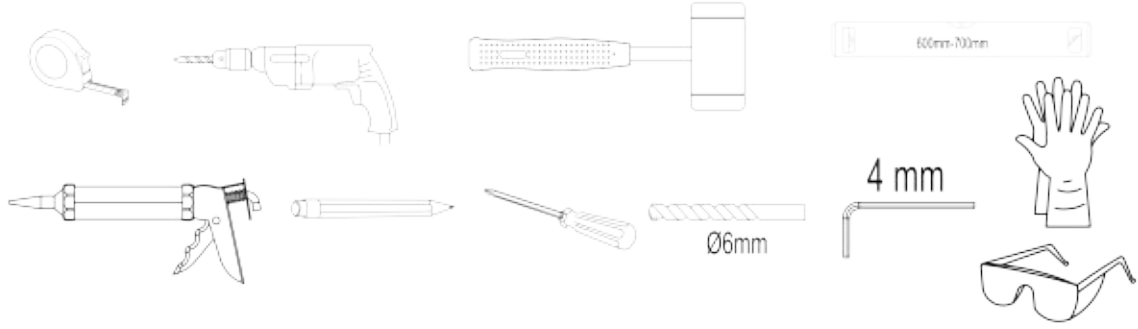
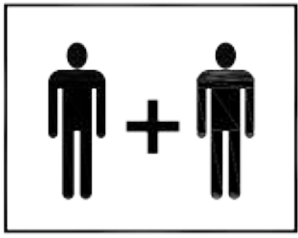
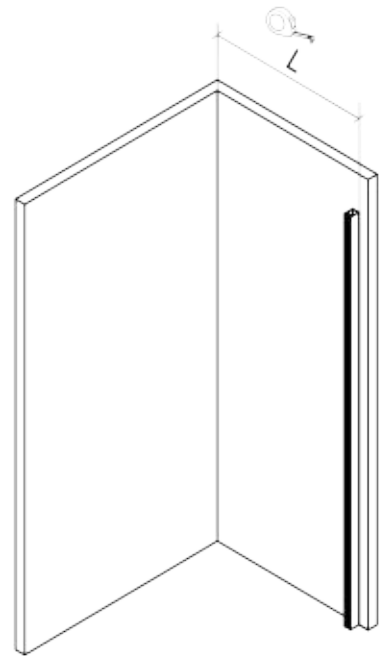
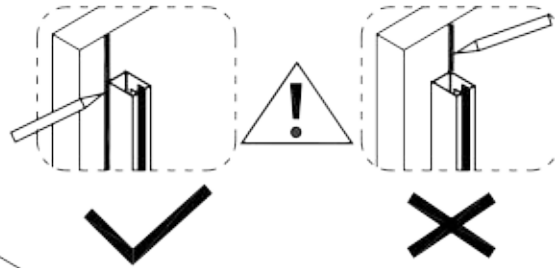
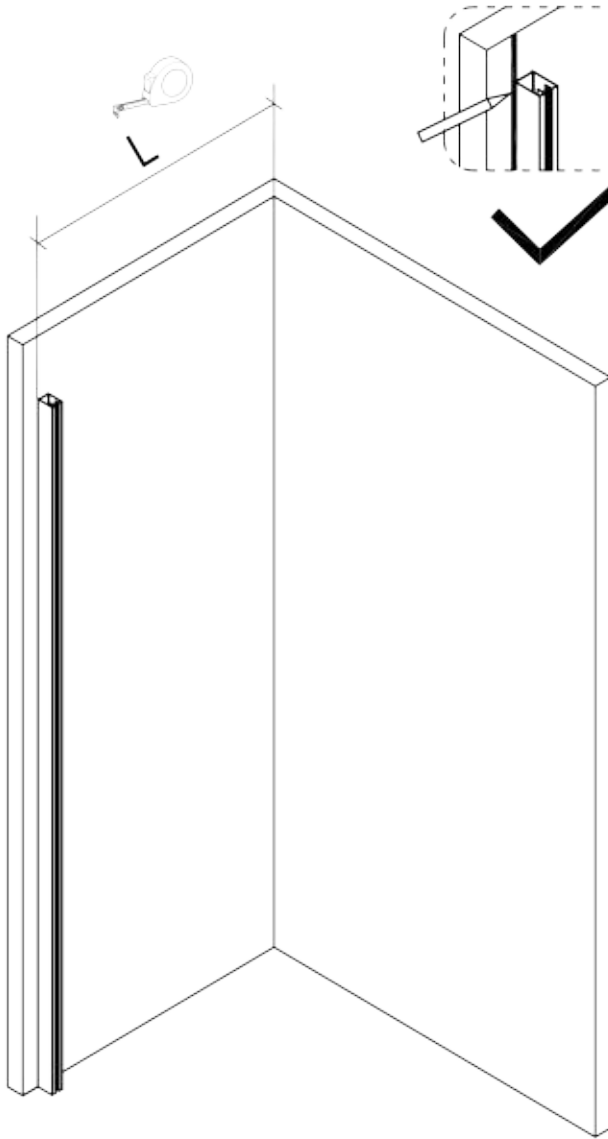
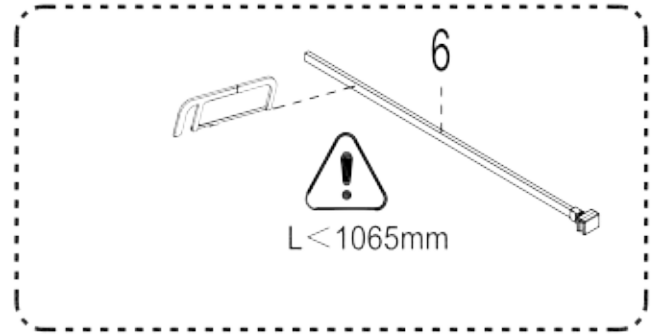
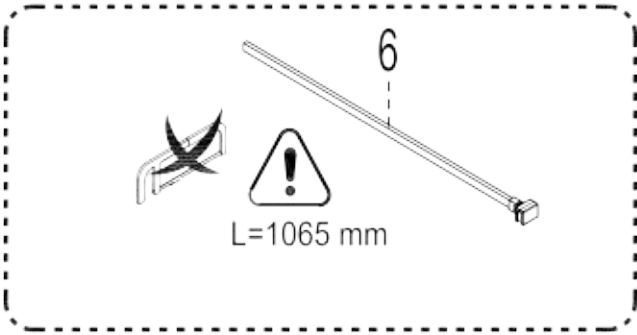

LH

RH

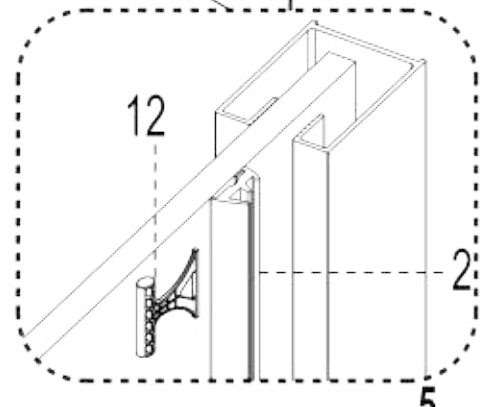
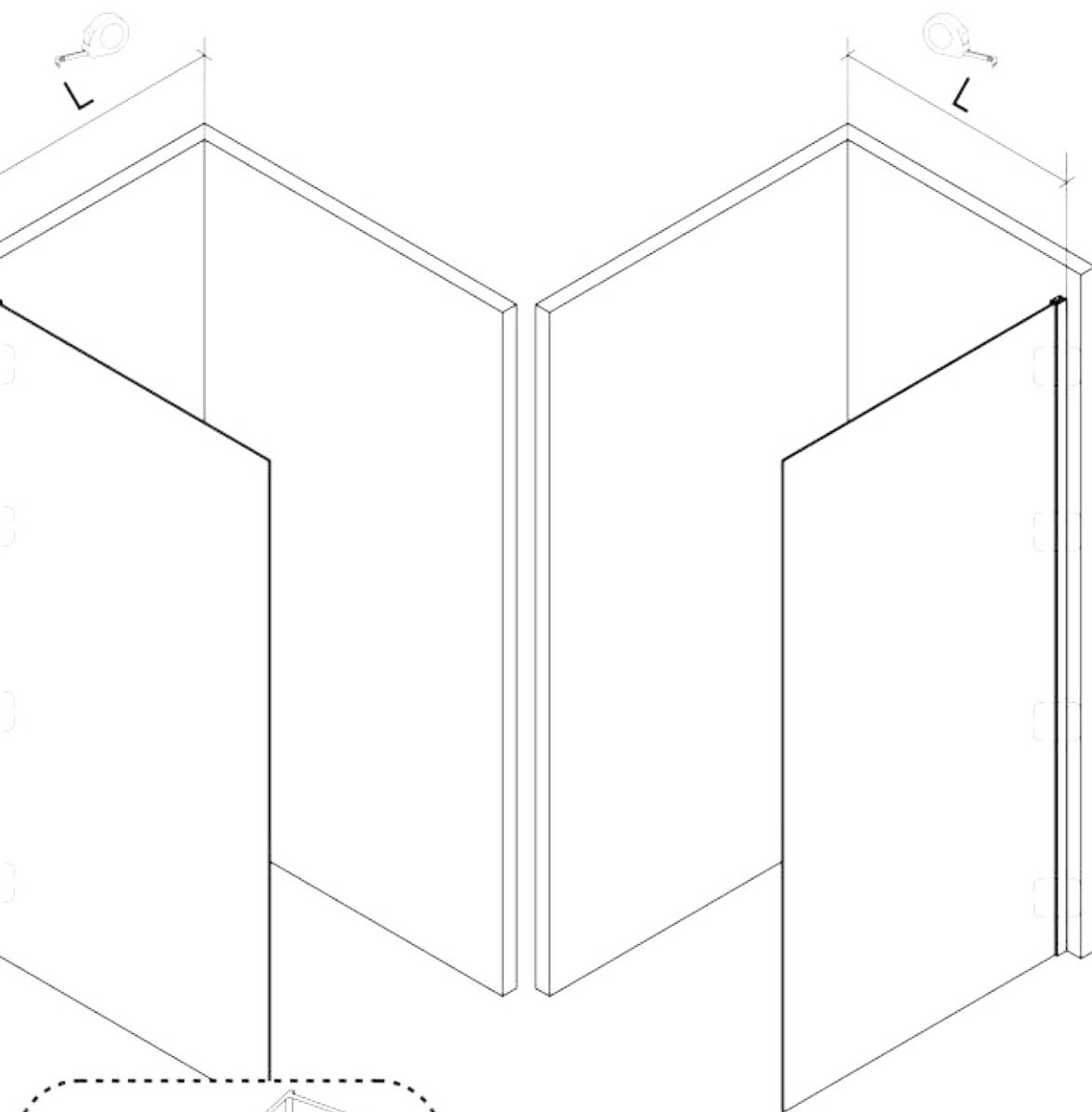
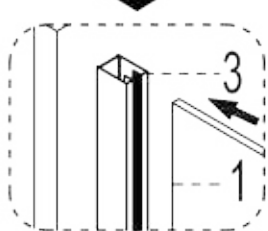
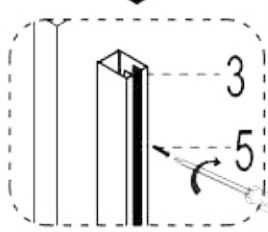
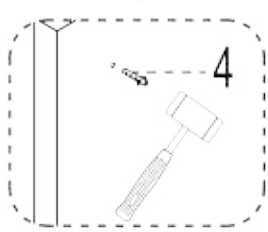
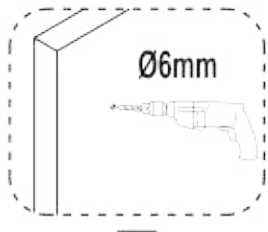
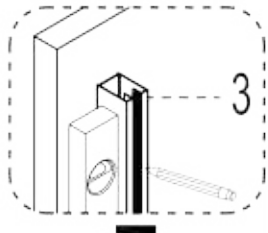
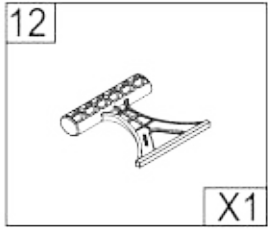
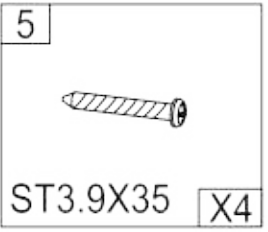
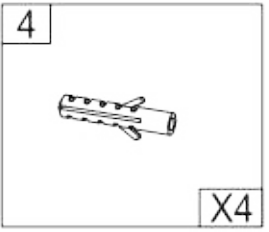
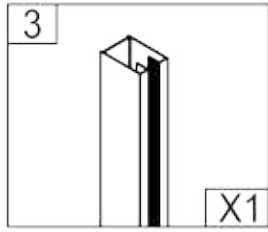
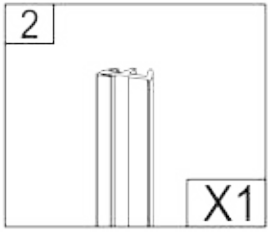
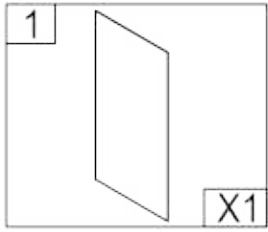
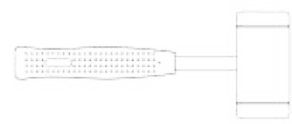

600mm-700mm



Ø6mm

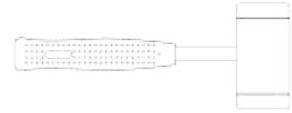

4 mm

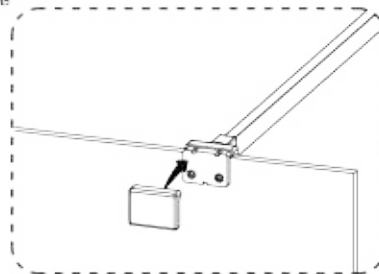
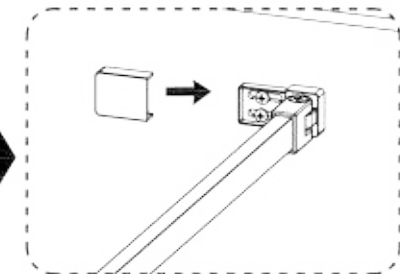
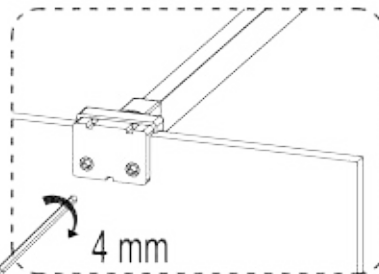
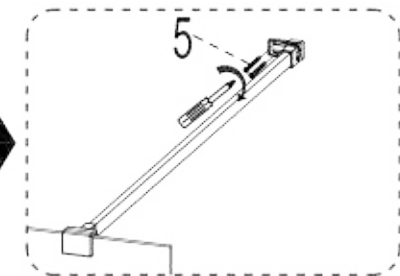
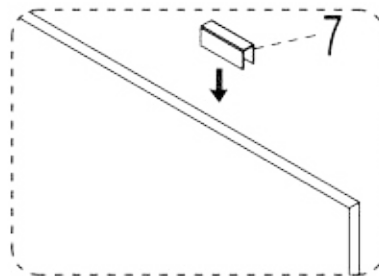
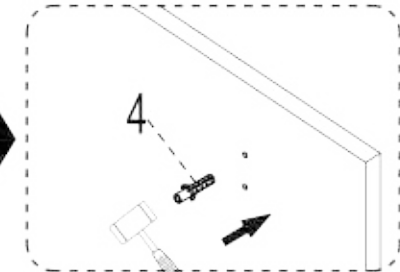
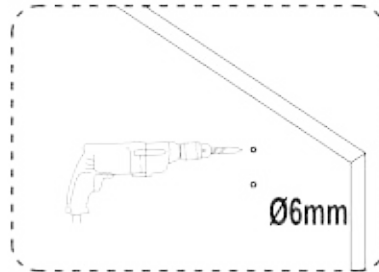
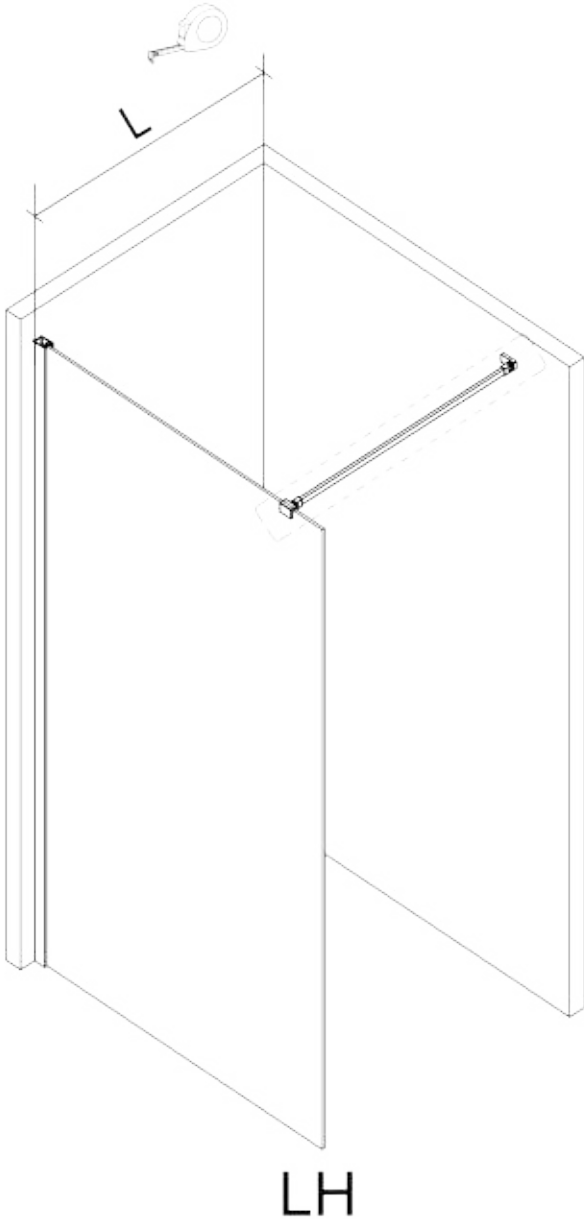
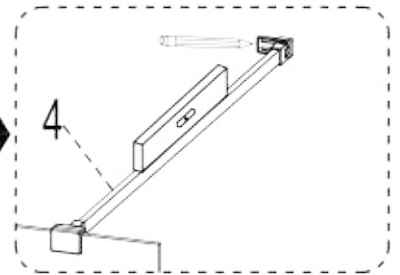
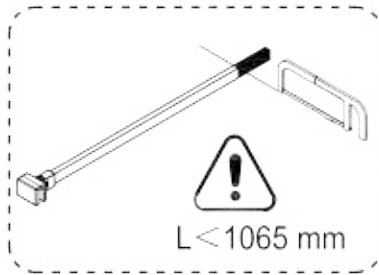
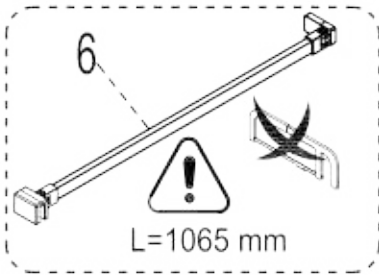
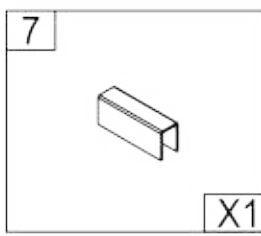
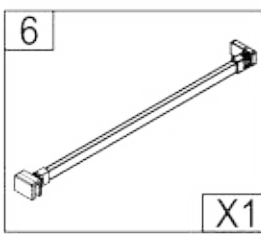
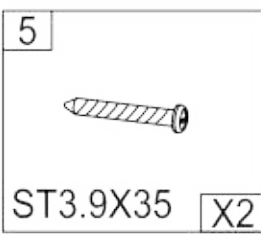
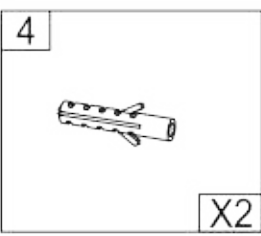

600mm-700mm



Ø6mm



4 mm

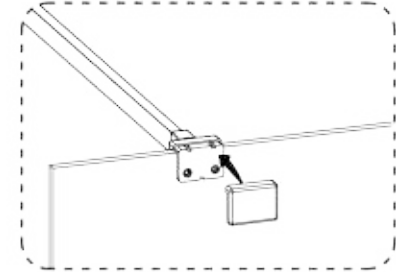
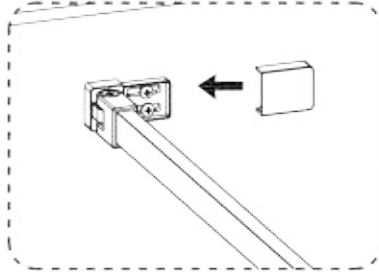
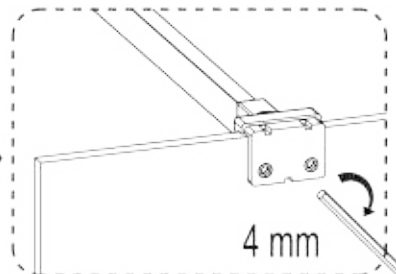
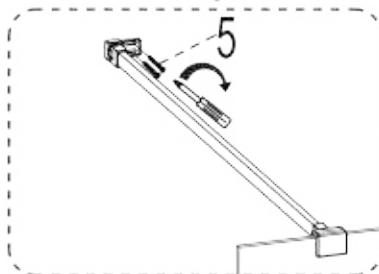
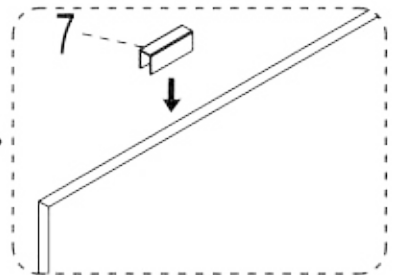
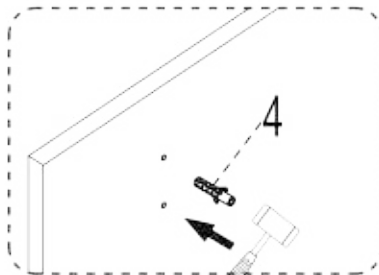
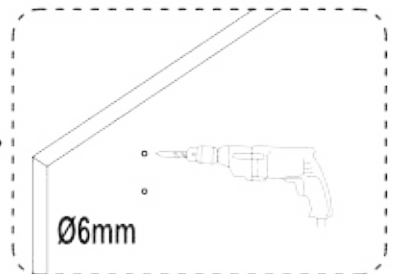
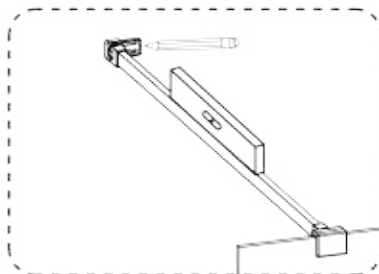
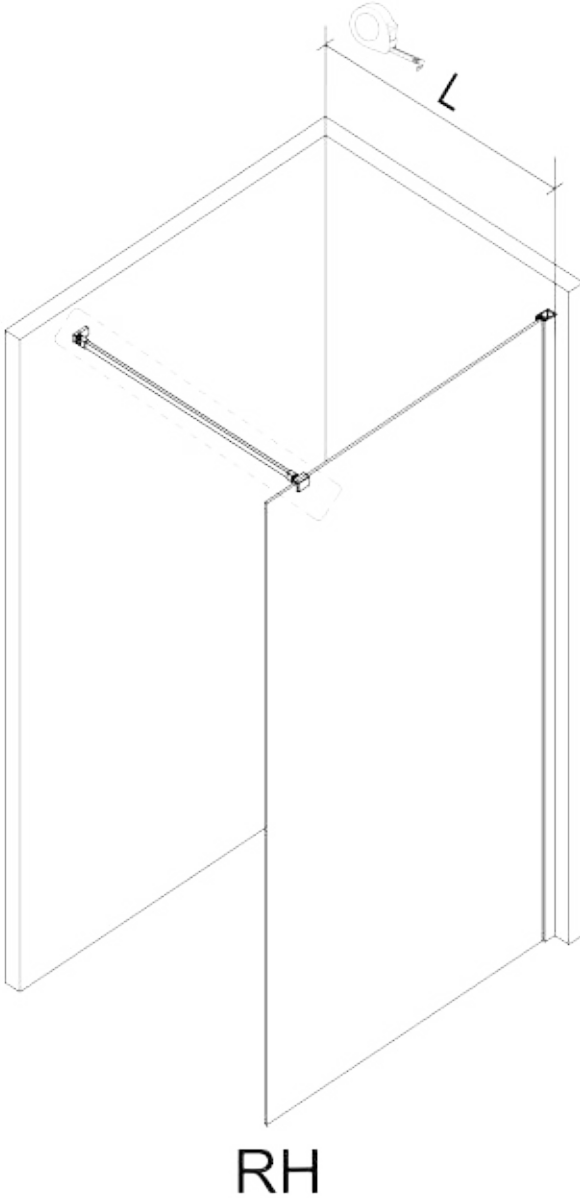
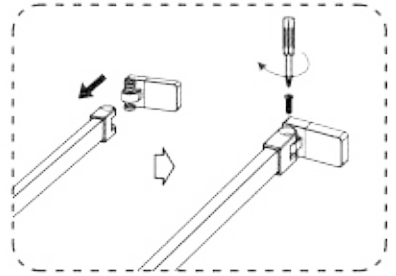
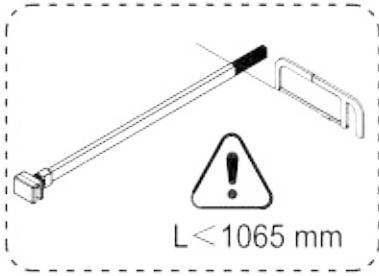
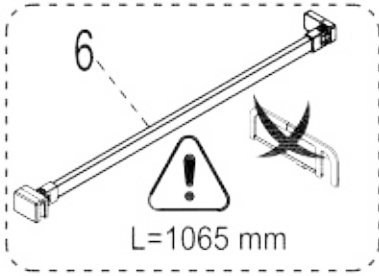
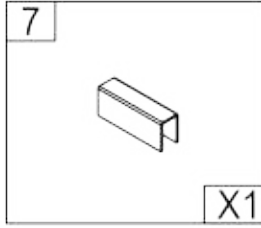
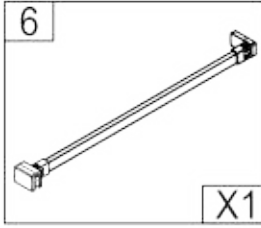
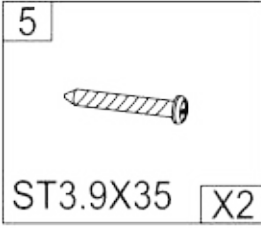
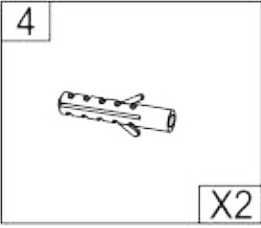

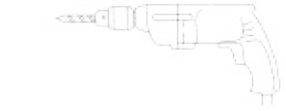

Ø6mm

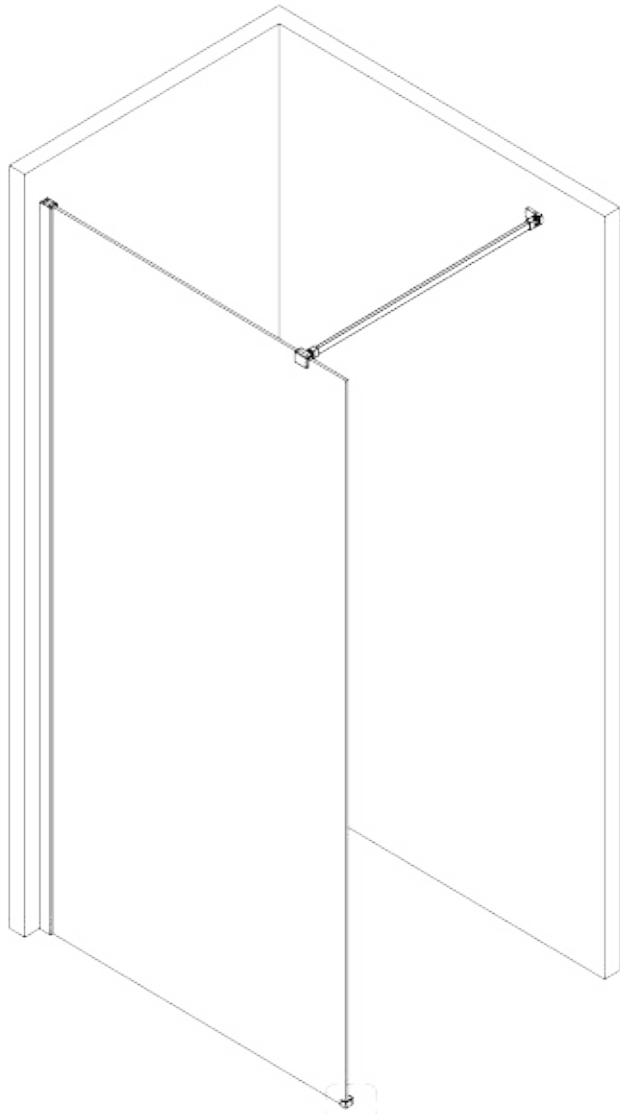
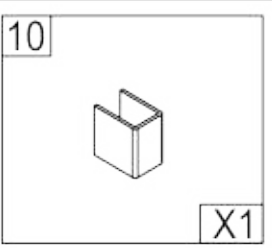
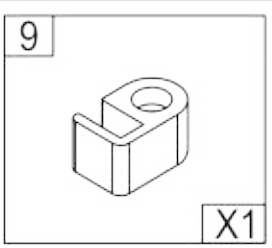
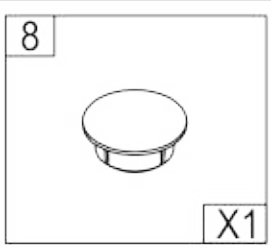
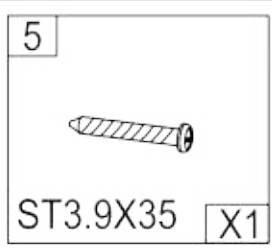
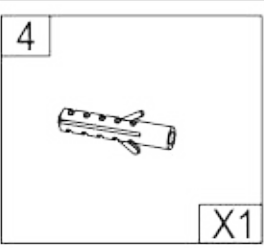
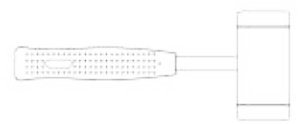

LH

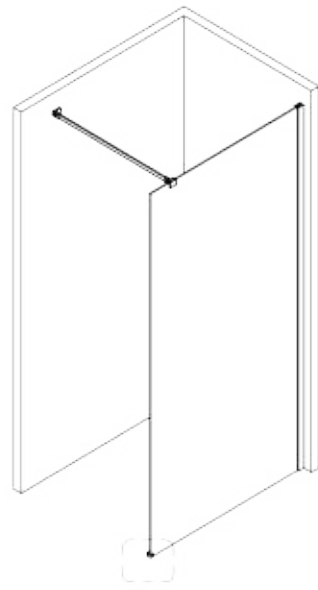

RH

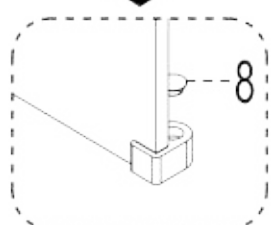
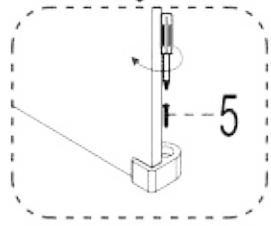
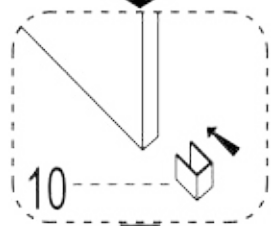
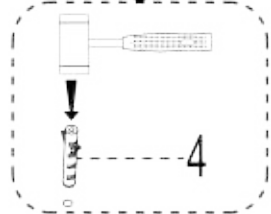
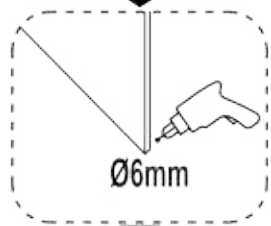
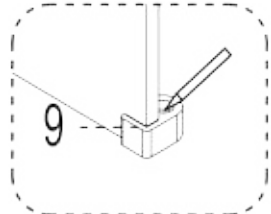

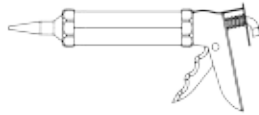

11

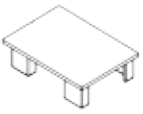

X1

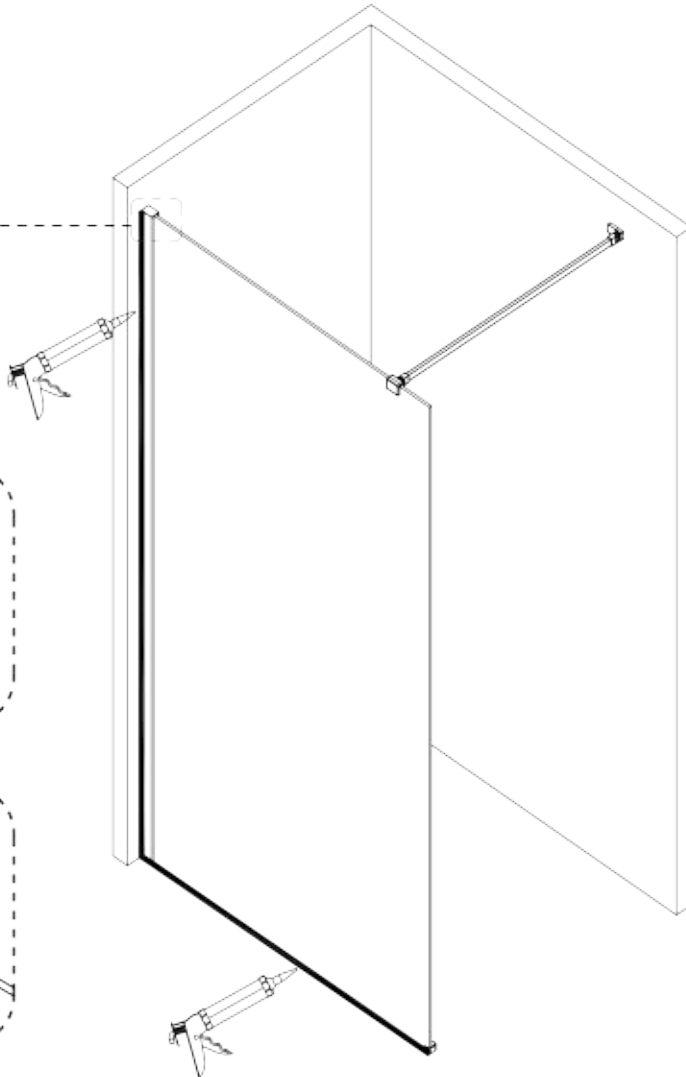
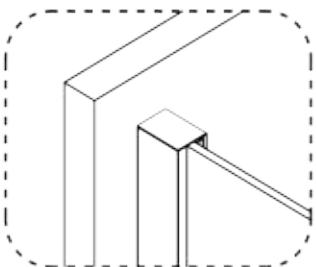
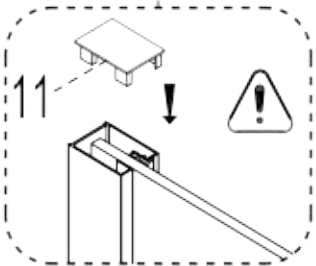
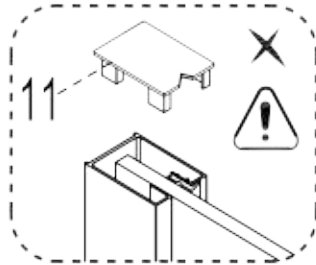
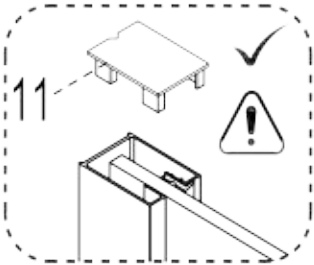

LH

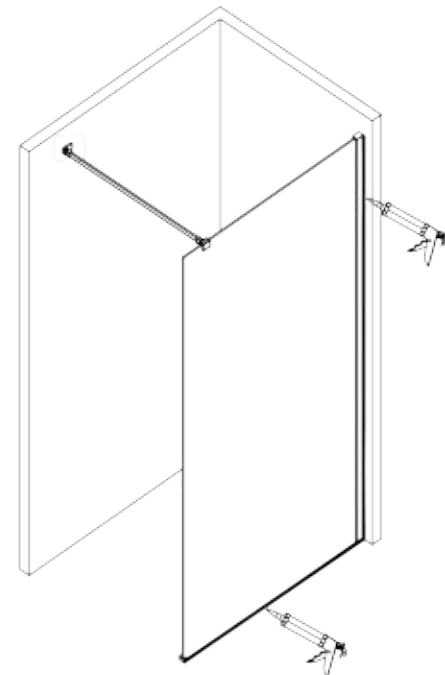

RH